



THE
ULTIMATE
OUTBOARD MOTOR

2021 SUZUKI OUTBOARD MOTORS

GENERAL CATALOGUE

THE
ULTIMATE
OUTBOARD MOTOR

DISCOVER THE ULTIMATE MARINE EXPERIENCE
WITH SUZUKI OUTBOARD MOTORS



Please read your Owner's Manual carefully. Remember, boating and alcohol or other drugs don't mix. Always wear a personal flotation device when boating. Please operate your outboard safely and responsibly.

Suzuki encourages you to operate your boat safely and with respect for the marine environment.

Specifications, appearances, equipment, colors, materials and other items of "SUZUKI" products shown in this catalogue are subject to change by manufacturers at any time without notice and they may vary depending on local conditions or requirements. Some models are not available in some territories. Each model might be discontinued without notice. Please enquire at your local dealer for details of any such changes. Actual body color might differ from the colors in this brochure.



SUZUKI MOTOR CORPORATION
300 TAKATSUKA-CHO, MINAMI-KU, HAMAMATSU-SHI, SHIZUOKA 432-8611 JAPAN
www.globalsuzuki.com

2021 OBM GENERAL CATALOG ENGLISH
99999-C1121-001
Printed in Japan 202008



This year we are celebrating our 100th anniversary.

On 15th of March, 1920, Michio Suzuki founded the Suzuki Loom Manufacturing Co. in Hamamatsu. Since then, we have expanded our business from looms to motorcycles, automobiles, outboard motors, ATV's and others, always adapting to the trend of the times as well as domestic and global markets. Your kind support at all times is truly the greatest factor that has enabled us to always be close to our customers' daily lives and achieve the commemorative 100th anniversary. All members of Suzuki Motor Corporation take this as an important milestone to reaffirm the founder's philosophy of "focusing on customers" and strive to deliver products to customers across the globe.



Suzulight(1955)

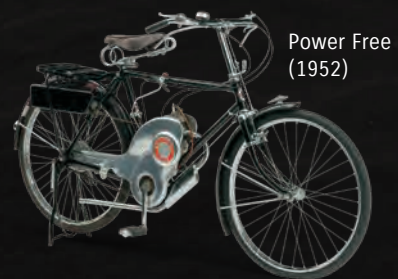

Power Free
(1952)

"If the customer needs something,
do whatever we can to respond.
We can do anything if we work hard"

Michio Suzuki, Founder



D55(1965)



GSX1100S KATANA
(1981)

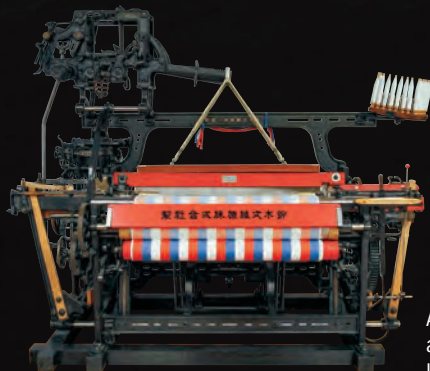

A44 single-sided
automatic four-shuttle
loom(1950)



Alto(1979)

100th
ANNIVERSARY



CONTENTS

- 4-8 SUZUKI ULTIMATE TECHNOLOGY**
- 9-11 NEW DF140BG/DF115BG**
Suzuki's DBW system series
- 12-13 Flagship-GEKI SERIES**
DF350A/325A/300B
- 14-15 V6 300-200HP**
DF300AP/250AP
DF250/225/200
- 16-17 IN-LINE 4 200-150HP**
DF200AP/175AP/150AP
DF200A/175A/150A
- 18-19 IN-LINE 4 140-70HP**
DF140BG/115BG
DF140A/115A/100A
DF100B/90A/80A/70A
- 20-21 IN-LINE 3 60-25HP**
DF60AV/50AV
DF60A/50A/40A
DF30A/25A
- 22-23 PORTABLE 20-2.5HP**
DF20A/15A/9.9B
DF9.9A/8A
DF6A/5A/4A
DF2.5
- 24-25 CARGO SERIES**
DF250W/150W/90AWQH
- 26-30 ECSTAR
PARTS & ACCESSORIES**
- 31-33 CLEAN OCEAN PROJECT
SUZUKI'S 9TH CLEAN-UP
THE WORLD CAMPAIGN**
- 34-35 HISTORY**
- 36-39 FEATURES & SPECIFICATIONS**

LEADING THE INDUSTRY WITH AWARD WINNING TECHNOLOGIES AND DESIGNS,
SUZUKI OUTBOARDS PROVIDE FEATURES AND BENEFITS THAT MAKE BOATING EVEN MORE ENJOYABLE

THE ULTIMATE OUTBOARD MOTOR

Durability & Reliability

- Hard to break
- Notice user before engine trouble
- Easy to service, repair

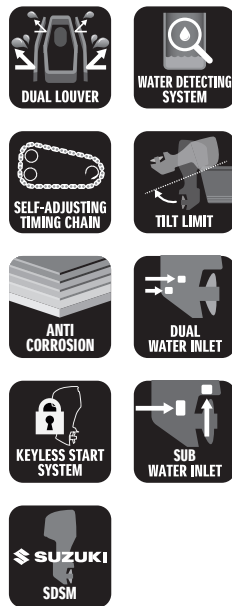

Performance

- Smooth and quick acceleration at all operating range
- Powerful torque

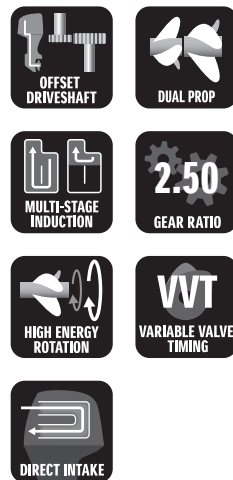

Easy & Comfort

- Less vibration
- Comfortable engine sound
- Light & compact
- Easy to use
- Smooth and decisive shifting



Ecology & Economy

- Good fuel efficiency / low exhaust
- Low maintenance cost
- Environment protection activities

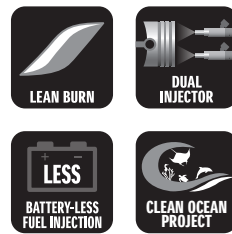

NMMA Award

The Innovation Awards (recognizing technological innovation) granted each year by the NMMA (National Marine Manufacturers Association) are considered among the highest honors in marine technology. Of the new marine industry products in that year, they are awarded to "a product that shows technical leadership, is practical and cost-effective, and is truly beneficial to the consumer."

Starting with the DT200 Exanté in 1987 and extending to the DF350A in 2017, Suzuki outboard motors have received this Innovation Award a total of nine times. Eight of these awards have been for 4-stroke outboard motors, which is the largest number of awards in the engine category in the industry.



Awarded Prizes

1987: DT200 Exanté / 1997: DF70 & DF60 /
1998: DF50 & DF40 / 2003: DF250 /
2006: DF300 / 2011: DF50A & DF40A / 2012: DF300AP /
2014: DF30A & DF25A / 2017: DF350A

Durability & Reliability



SUZUKI DUAL LOUVER SYSTEM

▶DF350A ▶DF325A ▶DF300B

The DF350A/DF325A/DF300B is equipped with a dog-leg shaped dual louver at the air intake to completely remove water from the air taken into the cowl.

ADVANTAGE

- Prevents water from entering the outboard.
- Allows a direct intake system, contributing to higher engine output.



SELF-ADJUSTING TIMING CHAIN

▶DF40A AND UP

The timing chain runs in an oil-bath so it never needs lubricating, and is equipped with an automatic hydraulic tensioner so it remains properly adjusted at all times.

ADVANTAGE

- More durability compared to belt types of same class.
- Maintenance-free.

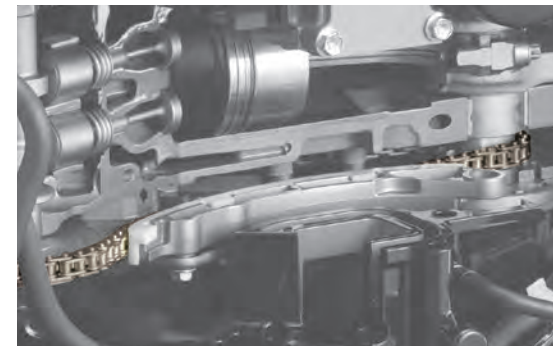

TILT LIMIT SYSTEM

▶DF50AV and up(not including DF90AWQH, DF60AQH, DF50A)

Tilt Limit System prevents the outboard from tilting beyond a selected angle.

ADVANTAGE

- Prevents damage to the boat or outboard due to excessive outboard tilting.

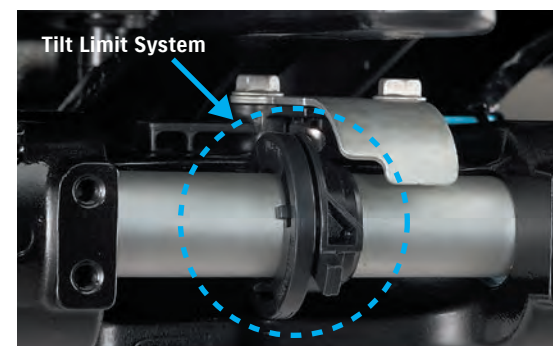

DF200A



WATER DETECTING SYSTEM

▶DF70A AND UP

It helps to protect the engine from water in the fuel using a water detecting fuel filter to alert the driver with both visual and audio warnings when water is present in the fuel.

ADVANTAGE

- Prevents water in fuel, which can be the cause of issues like poor combustion, lower power output and corrosion.



DUAL WATER INLET

▶DF350A ▶DF325A ▶DF300B ▶DF300AP ▶DF250AP ▶DF250W

The engine's cooling system relies on water supplied through two water inlets located on the lower unit where usually there is only one.

ADVANTAGE

- Increases the water flow, providing better cooling performance.

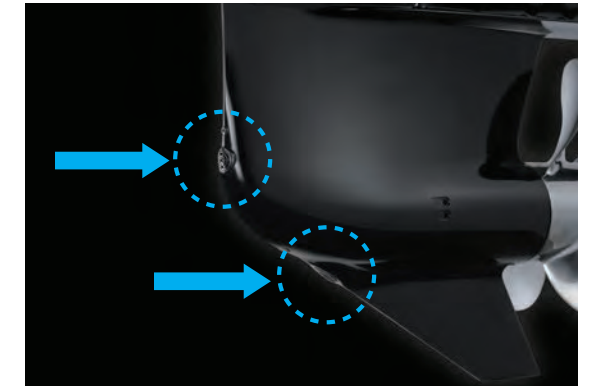

DF350A



SUB WATER INLET

OPTIONAL: ▶DF140A ▶DF115A ▶DF100A ▶DF90AWQH
STANDARD: ▶DF60A ▶DF50A ▶DF40A

Two water inlets in different directions ensure that the engine does not overheat due to the clogging of algae.



KEYLESS START SYSTEM

▶DF70A and above (not including DF250/225/200 DF250W, DF150W, DF90AWQH)

This system allows you to start the engine by having the key-fob nearby.

ADVANTAGE

- Provides high security.
- Key does not need to be inserted.



SUZUKI ANTI-CORROSION FINISH

▶ ALL MODELS

Special protection is applied to the aluminum surface using high strength bonding to protect the aluminum made exterior parts.

ADVANTAGE

- Protection against corrosion helps increase the overall outboard durability.

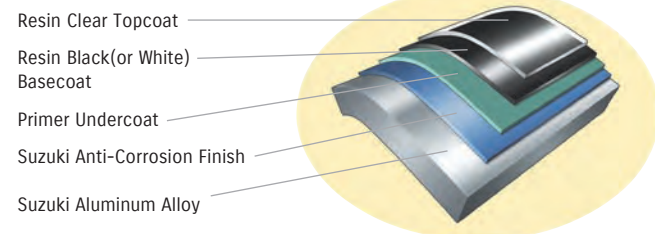

SDSM

Available for free*, this service enables you to scan the QR code containing the engine information displayed on the Multi-Function Display or Multi-Function Gauge with your smart phone and send the information via email

ADVANTAGE

- The SDSM App lets you send your authorized Suzuki dealer all the technical information they need to service and maintain your outboard motor instantly and easily.

* Suzuki Multi-function Gauge or Suzuki Multi-function Display and a smartphone running Android or iOS is required.



SUZUKI DUAL PROP SYSTEM

▶ DF350A ▶ DF325A ▶ DF300B

The Suzuki Dual Prop System spins two propellers rotating in opposite directions on a single engine.

ADVANTAGE

- Achieve superior stability when driving straight by eliminating the lateral forces associated with a single propeller.
- Engine power is transferred to the water more efficiently.
- Powerful reverse thrust and braking force.
- Less water resistance due to the small size of the gear case.
- Good water gripping performance and quick startup acceleration.



MULTI-STAGE INDUCTION

▶ DF250 ▶ DF225 ▶ DF200AP ▶ DF200A ▶ DF175AP ▶ DF175A ▶ DF150AP ▶ DF150A ▶ DF150W

Manifold pipes are switched between short and long during low speed and high speed operation to ensure the right volume of air enters the engine.

ADVANTAGE

- Increases output during high speed operation with greater volume of air input.
- Increases combustion efficiency and maximizes torque by increasing the density of the air intake during low speed operation.

AIR FLOW IN MULTI-STAGE INDUCTION MODULE

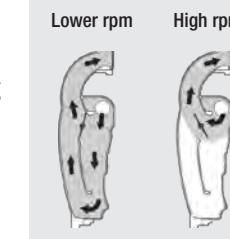

Performance



OFFSET DRIVESHAFT

▶ DF70A AND UP

The engine powerhead is positioned closer to the front, moving the outboard's center of gravity forward.

ADVANTAGE

- Less vibration
- More compact
- Stable steering performance

1st Stage Reduction : 30:36=1.20
2nd Stage Reduction : 12:25=2.08

Total : 2.50:1
DF200AP

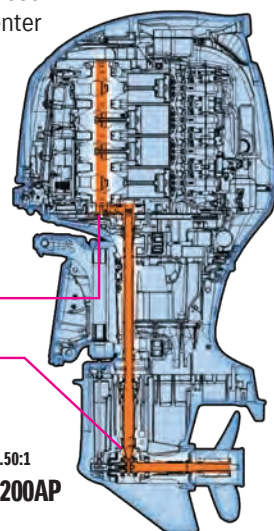

2-STAGE GEAR REDUCTION

▶ DF70A AND UP

This system which incorporates the Offset Driveshaft features a first stage reduction between the crankshaft and drive shaft, and a second stage reduction inside the gear case. This design makes a larger gear ratio possible, allowing it to turn a large diameter propeller.

ADVANTAGE

- Increased power to turn large diameter propellers, offering quick acceleration.
- High propulsive efficiency with large diameter propeller.
- Powerful navigation, maintaining propeller rotation even with a larger load.

GEAR RATIO IN EACH CLASS

MODEL	DF140BG/115BG DF140A/115A/100A DF100B/90A/80A/70A DF90AWQH	DF200A(AP)/ 175A(AP)/150A(AP) DF150W	DF250/ 225/200	DF300AP/ 250AP DF250W	DF350A/ 325A/300B
GEAR RATIO	2.59:1	2.50:1	2.29:1	2.08:1	2.29:1



VVT (Variable Valve Timing)

▶ DF350A ▶ DF325A ▶ DF300B ▶ DF300AP ▶ DF250AP ▶ DF250 ▶ DF250W ▶ DF200AP ▶ DF200A ▶ DF175AP ▶ DF175A ▶ DF150AP

The Variable Valve Timing is used to control the opening and closing timing of the intake valve depending on the engine operation.

ADVANTAGE

- Offers smooth, powerful torque.
- Provides increased acceleration during operation for all speed ranges.

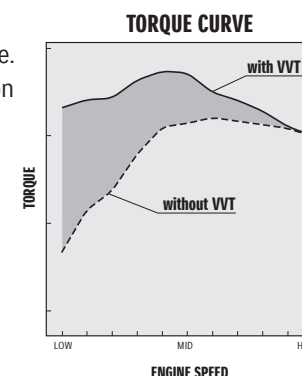

DIRECT AIR INTAKE

▶ DF350A ▶ DF325A ▶ DF300B

Designing a direct airflow path from the intake port to the cylinder suppresses any increase in the intake temperature and improves combustion efficiency.

ADVANTAGE

- Delivers higher power output from a small displacement with improved combustion efficiency.



HIGH ENERGY ROTATION

▶ DF60AV ▶ DF50AV

These outboard motors are equipped with gears designed with a 2.42 gear ratio, which is larger than the standard model, in their lower units. When combined with a large 36cm (14-inch) propeller, the powerful system can deliver an explosive forward thrust. This is ideal for heavy boats.

ADVANTAGE

- Powerful navigation and precise maneuvering even with big loads.
- Increased power to turn large diameter propellers, offering quick acceleration.
- Better hole shot.
- Superior low speed handling.

DF60AV vs. DF60A size comparison

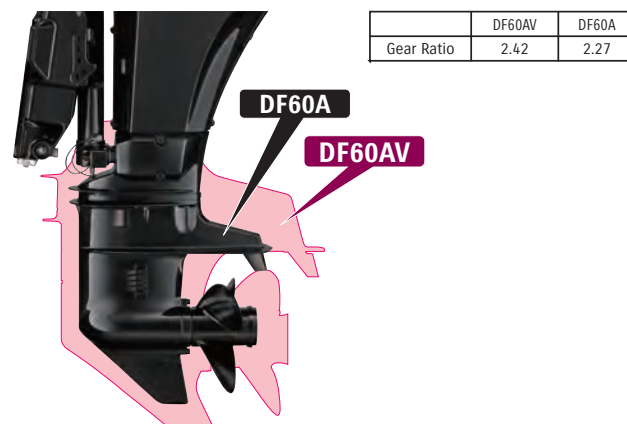

	DF60AV	DF60A
Gear Ratio	2.42	2.27

Easy & Comfort



SUZUKI SELECTIVE ROTATION

▶ DF300AP ▶ DF250AP ▶ DF200AP ▶ DF175AP ▶ DF150AP

Function for selecting regular or counter rotation on one outboard with an optional connector and a counter rotation propeller.

ADVANTAGE

- Either regular or counter rotation can be used on the same outboard.



SUZUKI PRECISION CONTROL (Electronic Throttle and Shift Systems)

▶ DF350A ▶ DF325A ▶ DF300B ▶ DF300AP ▶ DF250AP ▶ DF200AP ▶ DF175AP ▶ DF150AP ▶ DF140BG ▶ DF115BG

Operation from the remote control is delivered to the outboard via an electric signal and not by the traditional mechanical control cables.

ADVANTAGE

- Less friction and resistance compared to the mechanical type that uses actual control cables.
- Combined with the Lean Burn Control System, it offers improved fuel economy for a wide range of speed.
- Contributes to quick and reliable operation.





QUIET OPERATION

▶DF350A ▶DF325A ▶DF300B ▶DF200AP ▶DF200A
▶DF175AP ▶DF175A ▶DF150AP ▶DF150A
▶DF140BG ▶DF115BG

Intake noise is suppressed with a resonator, which makes the noise from the outboard quieter.

ADVANTAGE

- Less noise, making boating more pleasant.

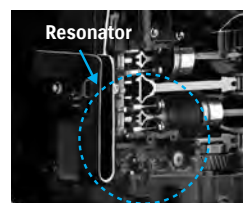

DF200A



OVERHEAD TANK

▶DF6A/5A/4A

The integral overhead fuel tank and one-way valve delivers fuel supply by using gravity.

ADVANTAGE

- Contributes to easy start.



GAS ASSIST SYSTEM

▶DF90AWQH ▶DF60AQH/40AQH ▶DF30AQH

Enables the outboard motor to be tilted up or down quickly with minimal force.



THREE-WAY STORAGE

▶DF6A ▶DF5A ▶DF4A

The design allows the outboard to be removed from the boat and placed on any of its 3 sides for storage.

ADVANTAGE

- No need to worry about the loading space or method.

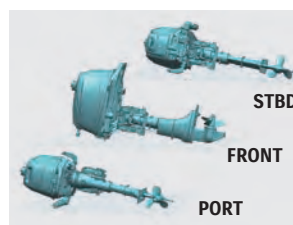

SUZUKI TROLL MODE SYSTEM* (Optional for Remote Control Models)

▶DF40A and up (not including DF250/225/200, DF250W, DF150W, DF90AWQH)

This system helps the boat running at a certain speed range in low revs. Equipped in all tiller handle models DF40A and up (except for DF90AWQH).

ADVANTAGE

- Boat can keep running at a certain speed range in low revs without having to operate the throttle on the boat.
- Gives you highly precise control at low revs.



*Available with SMD, SMG, or Troll Mode Switch Panel



SUZUKI EASY START SYSTEM

▶DF40A and up(except for DF250/225/200, DF250W, DF150W, DF90AWQH)

Simply turn the key and release, and the starter stays engaged until the engine starts. This system offers a smoother start of the engine.

Ecology & Economy



LEAN BURN CONTROL SYSTEM

LEAN BURN

▶DF9.9B and up (Not including DF250/DF225/DF200/DF150W)

The Lean Burn Control System supplies the right fuel and air mixture depending on the navigation conditions.

ADVANTAGE :

- Significant improvement in fuel economy in all speed ranges especially at cruising speed.
- Fuel is saved and gasoline costs are cut thanks to improved fuel economy.

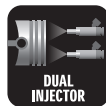

DUAL INJECTOR

▶DF350A ▶DF325A ▶DF300B

The dual injector delivers just the right amount of fuel at the right time into each cylinder.

ADVANTAGE :

- Contributes to higher output and better fuel efficiency.



BATTERY-LESS ELECTRONIC FUEL INJECTION

▶DF30A ▶DF25A ▶DF20A ▶DF15A ▶DF9.9B

This technology delivers quicker start, smoother operation, and more acceleration without a battery.

ADVANTAGE :

- Quick and easy start.
- Cleaner and economic fuel consumption.
- Higher and smoother performance in almost all operating ranges.
- Operates without battery.



SUZUKI CLEAN OCEAN PROJECT

Suzuki Clean Ocean Project was created to show Suzuki's commitment towards reducing marine plastic waste.

World's First Drive By Wire Model in 4-stroke 140/115HP*

*140HP:103kw, 115HP: 84.6kw

Drive By Wire

- Simplified Rigging
- Smooth Shifting & Instant Throttle



Easy Maintenance

- Oil Spill Catcher
- Easy Access Oil Filter Accessible just by removing the top cover

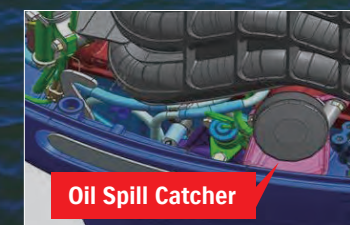

High Durability

- Improved Gear Case
 - Helps gear oil circulation
 - Prevents gear oil deterioration
 - Enhances durability of pinion gear

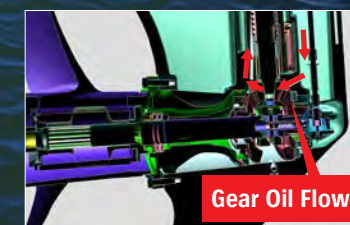

Dynamic & Smooth Design



New White Color

DF140BG NEW DF115BG NEW

STANDARD FEATURES

Durability & Reliability



Performance



Comfort

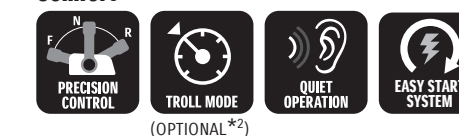

Ecology & Economy



*1 Available with SMD or SMG *2 Available with SMD, SMG, or Troll Mode Switch Panel

Suzuki's Drive By Wire Series

Taking your boating experience to a new level for your **ULTIMATE** marine life

Drive By Wire (Suzuki Precision Control System : S.P.C) is a technologically advanced computer-based control system with electronic wiring that eliminates the source of friction and resistance. While you enjoy smooth throttle and shift operation, the system's computer is processing and transmitting commands in real-time to actuators at the engine that deliver precise throttle controls with smoother, decisive shifting.



Smooth Shift Operation

Easy Rigging

Fuel Efficient

Luxury Remote Control

ULTIMATE Line-up New White Color Available



DF350A



DF325A



DF300B



DF300AP



DF250AP



DF200AP



DF175AP



DF150AP



DF140BG



DF115BG

V6 350-300HP Flagship-GEKI SERIES

◆ Drive By Wire DF350A / DF325A / DF300B

THE
ULTIMATE
OUTBOARD MOTOR



SUZUKI DUAL LOUVER SYSTEM P5

The DF350A/DF325A/DF300B is equipped with dual louver at the air intake to remove water from the air taken into the cowl. Incorporating a direct intake system makes the highest compression ratio of 12.0:1 (DF350A), 10.5:1 (DF325A/DF300B) possible, ultimately leading to a higher engine output.

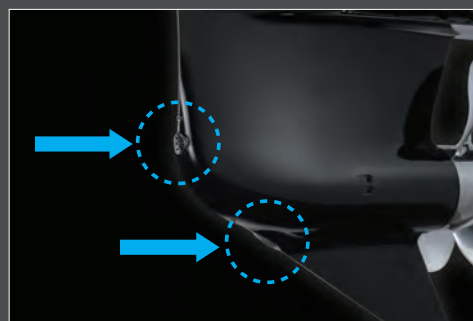

DUAL WATER INLET P5

The engine's cooling system relies on water supplied through low water intakes located on the lower unit. This dual water inlet configuration increases water flow into the lower unit, delivering greater cooling efficiency. Positioning the forward inlet by the gear case nose delivers a greater water supply, especially at high speeds. The second inlet is positioned lower, allowing the DF350A/DF325A/DF300B to operate in shallow water.

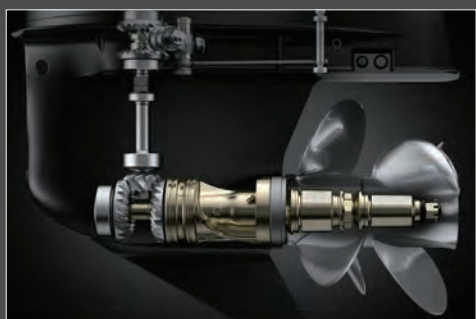

SUZUKI DUAL PROP SYSTEM P7

The dual prop system efficiently turns DF350A/DF325A/DF300B horsepower output into propulsion under water. As an added benefit, because each propeller rotates in a different direction, exceptional stability is achieved. In addition, the contra-rotating propellers produce a strong reverse thrust.



DUAL INJECTOR P8

Dual injectors deliver just the right amount of fuel at just the right time into the cylinder. This dual injector contributes to higher output and better fuel efficiency.



ANTOINE GUILLOU

SMD16 / SMD12 P27

Big screen navigation for large boats. The SMD16/SMD12 allows you to choose the screen size that best matches your helm or bridge needs. You can build your system with the best sensors and technologies to suit your needs.

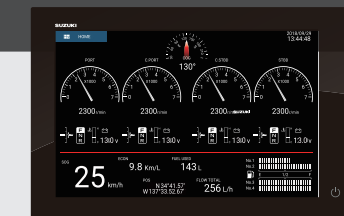

New White Color

DF350A

DF325A / DF300B

DRIVE BY WIRE



DF350A



Find out more by



GEKI: PARTING SEAS

A Force to Match the Power of Nature and the Sea Representing Suzuki's Identity and Heritage. A Symbol of Our Passion and Commitment to the Ultimate in Marine Innovation.

* "GEKI: PARTING SEAS" is the logo that represents the DF350A, DF325A and DF300B

Durability & Reliability

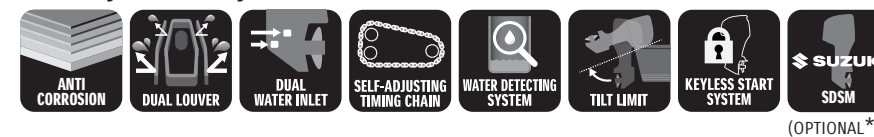

Performance



Easy & Comfort

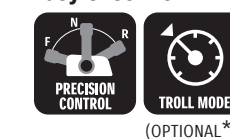

Ecology & Economy

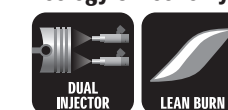

SPECIFICATIONS / FEATURES P36 P37

*1 Available with SMD or SMG

*2 Available with SMD, SMG, or Troll Mode Switch Panel

V6 300-200HP

- ◆ Drive By Wire DF300AP / DF250AP
- ◆ Mechanical DF250 / DF225 / DF200

THE
ULTIMATE
OUTBOARD MOTOR



Increased Alternator Output at Low Speed

Ideal for today's power-hungry fishing boats that spend a lot of time trolling

Applicable models : V6 models (DF350A-DF200)*

ADVANTAGE

- Increased alternator output ability at idle and low speed.
- Enables the use of more electric equipments.

At Idling Speed	18A → 28A*	156%
At Idle in Gear	23A → 33A*	143%
At 1,000rpm	38A → 43A*	

* Applicable from June 2020 production models.



New White Color

DF300AP
DF250AP

DRIVE BY WIRE

New White Color

DF250
DF225 / DF200

MECHANICAL

STANDARD FEATURES

Durability & Reliability

- ANTI CORROSION (ALL MODELS)
- SELF-ADJUSTING TIMING CHAIN (ALL MODELS)
- WATER DETECTING SYSTEM (ALL MODELS)
- TILT LIMIT (ALL MODELS)
- SDSM (OPTIONAL*1)

Performance

- 2.29 GEAR RATIO (DF250, DF225, DF200)
- 2.08 GEAR RATIO (DF300AP, DF250AP)
- OFFSET DRIVESHAFT (ALL MODELS)
- VARIABLE VALVE TIMING (DF300AP, DF250AP, DF250)
- MULTI-STAGE INDUCTION (DF250)

ADDITIONAL FEATURES FOR DRIVE BY WIRE MODEL

Durability & Reliability

- DUAL WATER INLET (DF300AP, DF250AP)

Easy & Comfort

- SELECTIVE ROTATION (DF300AP, DF250AP)
- PRECISION CONTROL (DF300AP, DF250AP)
- TROLL MODE (OPTIONAL*2)
- KEYLESS START SYSTEM (DF300AP, DF250AP)

Ecology & Economy

- LEAN BURN (DF300AP, DF250AP)

SPECIFICATIONS / FEATURES P36 P37

*1 Available with SMD or SMG

*2 Available with SMD, SMG, or Troll Mode Switch Panel

IN-LINE 4 200-150HP

- ◆ Drive By Wire DF200AP / DF175AP / DF150AP
- ◆ Mechanical DF200A / DF175A / DF150A

THE
ULTIMATE
OUTBOARD MOTOR



DF200AP
DF175AP / DF150AP
DRIVE BY WIRE

DF200A
DF175A / DF150A
MECHANICAL

SMD16 / SMD12

Big screen navigation for large boats. The SMD16 / SMD12 allows you to choose the screen size that best matches your helm or bridge needs. You can build your system with the best sensors and technologies to suit your needs.



SUZUKI SELECTIVE ROTATION

P7



Function for selecting regular or counter rotation on one outboard with an optional connector.

QUIET OPERATION

P8

Intake noise is suppressed with a resonator, which makes the noise from the outboard quieter.

STANDARD FEATURES

Durability & Reliability



Performance

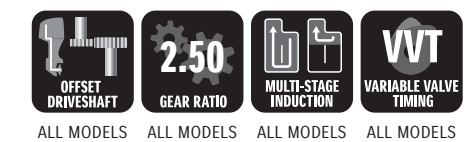

Easy & Comfort

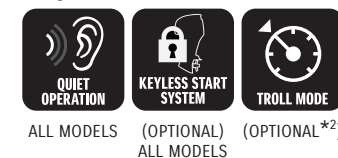

Ecology & Economy



ADDITIONAL FEATURES FOR DRIVE BY WIRE MODEL

Easy & Comfort

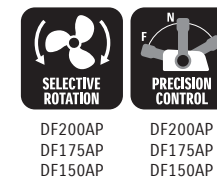

SPECIFICATIONS / FEATURES P36 P37

*1 Available with SMD or SMG

*2 Available with SMD, SMG, or Troll Mode Switch Panel

IN-LINE 4 140-70HP

- ◆ Drive By Wire DF140BG / DF115BG
- ◆ Mechanical DF140A / DF115A / DF100A , DF100B / DF90A / DF80A / DF70A

THE
ULTIMATE
OUTBOARD MOTOR



NEW DF140BG
NEW DF115BG
DRIVE BY WIRE
P9

DF140A
DF115A / DF100A
MECHANICAL

DF100B
DF90A / DF80A / DF70A
MECHANICAL
■ Tiller handle model available (For 90HP & 70HP)

DF100A

For customers who have heavy boats and need more torque & power (e.g. Large size boat / Commercial Boat)

DF100B

For customers who use light weight boats and need quick acceleration (e.g. Compact size boat / Inflatable Boat)

	DF100A	DF100B
Displacement(cm ³)	2,045	1,502
Weight(kg)	L : 182	L : 157
Gear Ratio	2.59 : 1	

2-STAGE GEAR REDUCTION

P6

This design makes a larger gear ratio possible, allowing it to turn a large diameter propeller.

MULTI-FUNCTION TILLER HANDLE

P29



Suzuki's ergonomically designed tiller handle provides comfortable operation of the outboard whether operated with the left or right hand.

MAINTENANCE KIT*

P29



Each maintenance kit has the complete range of Suzuki Genuine Parts required for servicing Suzuki outboard motors according to the periodical maintenance schedule as detailed in the owner's manual.

*Available for all models

STANDARD FEATURES

Durability & Reliability

- ANTI CORROSION (ALL MODELS)
- SELF-ADJUSTING TIMING CHAIN (ALL MODELS)
- WATER DETECTING SYSTEM (ALL MODELS)
- TILT LIMIT (ALL MODELS)
- KEYLESS START SYSTEM (OPTIONAL) (ALL MODELS)
- SDSM (OPTIONAL*¹) (OPTIONAL*¹)

Performance

- OFFSET DRIVESHAFT (ALL MODELS)
- GEAR RATIO 2.59 (ALL MODELS)

Easy & Comfort

- TROLL MODE (OPTIONAL*²) (REMOTE CONTROL MODELS (STANDARD) TILLER HANDLE MODELS)

Ecology & Economy

- LEAN BURN (ALL MODELS)

ADDITIONAL FEATURES FOR DRIVE BY WIRE MODEL

Easy & Comfort

- PRECISION CONTROL (DF140BG / DF115BG)
- QUIET OPERATION (DF140BG / DF115BG)

SPECIFICATIONS / FEATURES P36 P37

*1 Available with SMD or SMG

*2 Available with SMD, SMG, or Troll Mode Switch Panel

IN-LINE 3 60-25HP

DF60AV / DF50AV
DF60A / DF50A / DF40A
DF30A / DF25A



THE
ULTIMATE
OUTBOARD MOTOR



HIGH ENERGY ROTATION

These outboards are equipped with gears designed with a 2.42 gear ratio, which is larger than the standard model, in their lower units. When combined with a large 36cm (14-inch) propeller, the powerful system can deliver an explosive forward thrust. This is ideal for heavy boats.

ADVANTAGE

- Powerful navigation and precise maneuvering even with big loads.
- Tremendous power to turn large diameter propellers, offering quick acceleration.

DF60AV vs. DF60A size comparison

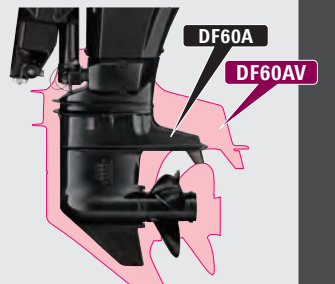

	DF60AV	DF60A
Gear Ratio	2.42	2.27

BATTERY-LESS EFI

P8

This technology delivers quicker start, smoother operation, and more acceleration without a battery.

BATTERY CHARGING KIT

P29



Optional equipment for charging battery.

TROLL MODE + SMG

P28



Allows you to control your troll mode from the Multi-Function Gauge.



DF60AV

DF50AV

HIGH ENERGY ROTATION

■ Tiller handle model available



New White Color

DF60A

DF50A / DF40A

■ Tiller handle model & gas assist model available

*1 Available with SMD or SMG



STANDARD FEATURES

Durability & Reliability



ALL MODELS
ALL MODELS (not including Gas Assist models & DF50A/40A)
ALL MODELS (OPTIONAL*1)

Performance Easy & Comfort Ecology & Economy



DF60AV / DF50AV
(OPTIONAL*2)
ALL MODELS
ALL MODELS

*2 Available with SMD, SMG, or Troll Mode Switch Panel



DF30A

DF25A

BATTERY-LESS EFI

■ Gas assist model available
■ Remote Control model available



STANDARD FEATURES

Durability & Reliability



(OPTIONAL*1)

Ecology & Economy



LEAN BURN
LESS BATTERY-LESS FUEL INJECTION

SPECIFICATIONS / FEATURES P38 P39

*1 Available with SMD or SMG

PORTABLE 20-2.5HP

DF20A / DF15A / DF9.9B
DF9.9A / DF8A
DF6A / DF5A / DF4A
DF2.5



THE
ULTIMATE
OUTBOARD MOTOR



BATTERY-LESS EFI

P8

This technology delivers quicker start, smoother operation, and more acceleration without a battery.

OVERHEAD TANK

P8

The integral overhead fuel tank and one-way valve delivers fuel supply using gravity.

THREE-WAY STORAGE

P8

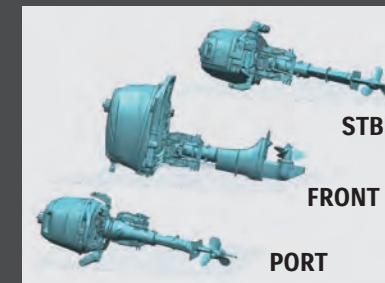

The design allows the outboard to be removed from the boat and placed on any of its 3 sides for storage.



New White Color

New White Color

DF20A

DF15A / DF9.9B

BATTERY-LESS EFI

■ Remote control model available

DF9.9A

DF8A

DF6A

DF5A / DF4A

THREE-WAY STORAGE

DF2.5

STANDARD FEATURES

Durability & Reliability



ALL MODELS (OPTIONAL *1)
DF20A
DF15A
DF9.9B

Easy & Comfort



DF6A
DF5A
DF4A

Ecology & Economy



DF20A
DF15A
DF9.9B

SPECIFICATIONS / FEATURES P38 P39

*1 Available with SMD or SMG

Model Series that meets the demand of the Commercial Market

- Suzuki's first Commercial series
- Each model designed to fit the needs of commercial users
- Red stripe on side
- "Cargo" decal on back

Strengthened features for heavy duty use*

- Chromium plated water pump inner wall
- Fluorine coated rubber materials for the fuel system (e.g. Vapor separator)
- Fuel injection system made specifically for heavy duty use

The Technology Behind Powerful Suzuki Outboard Motors*

OFFSET DRIVESHAFT

- Less vibration
- More compact
- Stable steering performance

1st Stage Reduction :
=1.24

2nd Stage Reduction :
=2.08

Total : 2.59:1

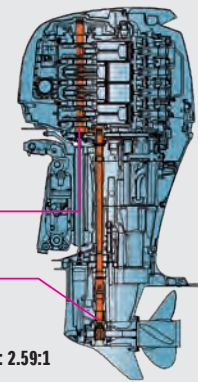

2-STAGE GEAR REDUCTION

- High Torque
- Powerful enough to use larger propeller
- Maintain power even with large loads

GEAR RATIO IN EACH CLASS

MODEL	DF150W	DF250W	DF90AWQH
GEAR RATIO	2.50:1	2.08:1	2.59:1

*Applicable to all Cargo Series models.



DF250W

For Commercial Transport Business

- DURABILITY & RELIABILITY - STRENGTHENED GEAR
- HIGH TORQUE

STANDARD FEATURES

Durability & Reliability



Performance



DF150W

For General Commercial Use

- DURABILITY & RELIABILITY
- HIGH TORQUE

STANDARD FEATURES

Durability & Reliability



Performance



*1 Available with SMD or SMG

DF90AWQH

For Commercial Fishing

- DURABILITY & RELIABILITY
- HIGH TORQUE
- EASY HANDLING
- BATTERY CHARGEABLE AT IDLE SPEED

STANDARD FEATURES

Durability & Reliability

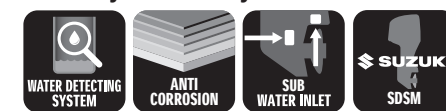

Performance



Easy & Comfort



SPECIFICATIONS / FEATURES P36 P37

*1 Available with SMD or SMG

ECSTAR

GENUINE OIL & CHEMICAL

What is ECSTAR

ECSTAR is a global brand name of SUZUKI Genuine Oil & Chemicals.

The ULTIMATE Formulation

Suzuki Approved Genuine engine oils have all been rigorously tested and certified by Suzuki engineers. So you can be confident that they'll help keep your Suzuki outboard in perfect condition, giving you maximum performance and reliability over its lifetime.

Replacement Guideline (Engine oil)

Interval	1st time	20 hours or 1 month*
	From 2nd time	100 hours or 1 year*

*whichever comes first

This guideline may vary by outboard motor model, condition of use, region, etc. Please refer to the owner's manual or ask an authorized Suzuki dealer for more information.

ECSTAR Line up for OUTBOARD MOTOR

ENGINE OIL



ECSTAR V7000
10W-40 SEMI SYNTHETIC

ECSTAR V5000
10W-40 MINERAL

GEAR OIL



ECSTAR
OBM GEAR OIL SAE90

Availability may differ in some regions. Please contact your Suzuki local dealer.

PARTS & ACCESSORIES

THE ULTIMATE
OUTBOARD MOTOR

SUZUKI MULTI-FUNCTION DISPLAY (SMD)

DF9.9B AND UP

SUZUKI MULTI-FUNCTION DISPLAY is available in four screen sizes: 16 inch, 12 inch, 9 inch, 7 inch



SMD16



SMD9



SMD12



SMD7

KEY FEATURES

- Intuitive, easy, smooth operation with an entire multi touch screen interface. Total control at your fingertips
- Bonded all-glass LCD, sunlight viewable screen with impressive brightness, and a luxurious look
- Ease of operation with all Suzuki engine information integrated on one display
- All latest and unique technologies such as TruEcho Chirp™, Accu-Fish™, RezBoost™ combined in one display provide you the most exciting fishing experience

SMD NETWORK RECOMMENDATIONS

Product suggestion only - Not an installation diagram. Please contact your local Authorized Suzuki Dealers for more details.

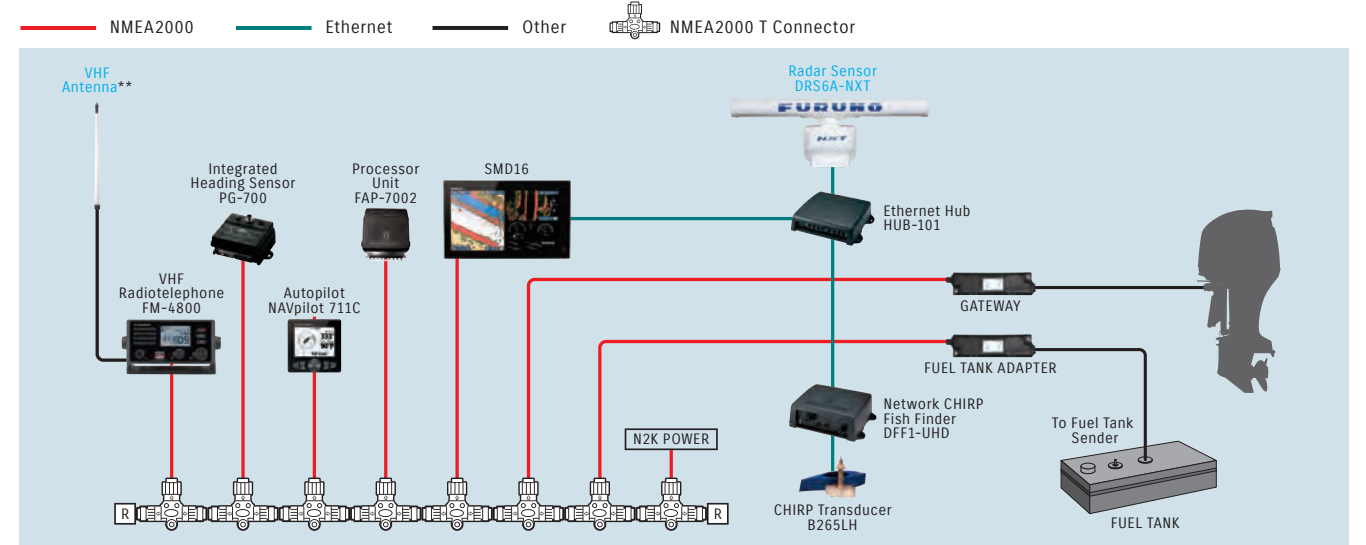

* Recommendation for Common Runabout
** Local supply

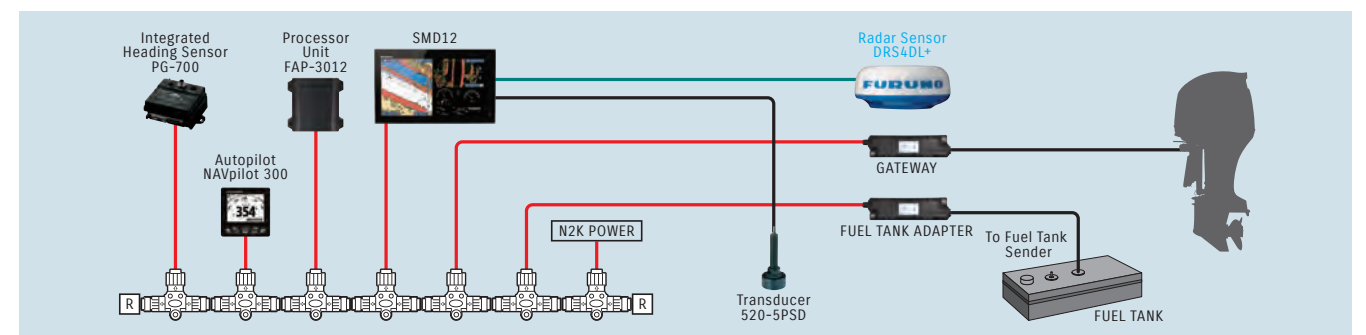

* Recommendation for Common Runabout

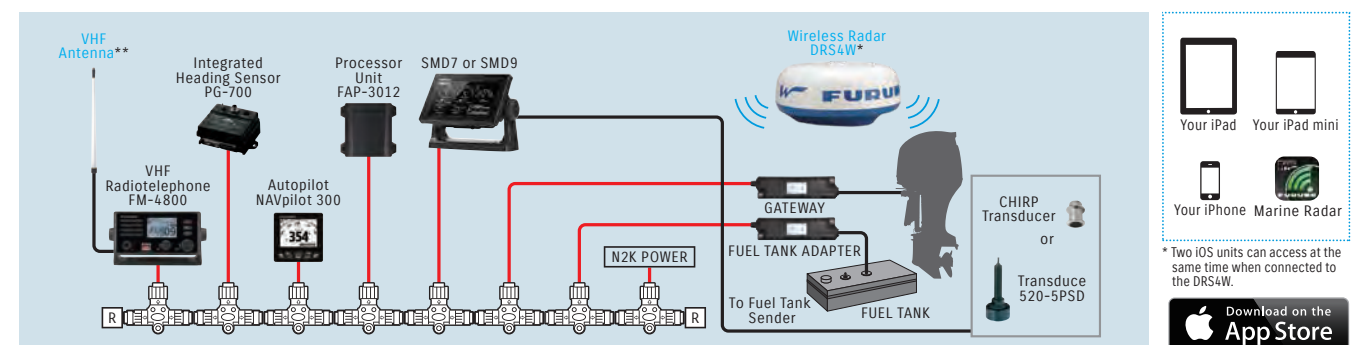

* Two iOS units can access at the same time when connected to the DRS4W.



* Recommendation for Common Runabout

WHAT'S NEW!

SUZUKI GENUINE FUEL TANK ADAPTER

DF9.9B AND UP

The genuine fuel tank adapter is designed to be compatible with SMD



NEW WIRELESS SOLUTION - MIRRORING CONTROL APP 2 WAY COMMUNICATION!

DF9.9B AND UP

Combination with iOS/Android device increases the controllable station via Wireless LAN

The following App supports the mirroring control of SMD7/9 over an iOS/Android devices



App : Mirroring Control (free of charge)
Seller : AvMap Sri

For iOS (App Store) :
<https://apps.apple.com/nz/app/mirror-control/id940193674>
For Android (Google Play) :
https://play.google.com/store/apps/details?id=mirrorControl.impl&hl=en_US

SUZUKI MULTI-FUNCTION GAUGE (SMG4)

DF9.9B AND UP

Offering a genuine color display, Suzuki's Multi-Function Gauge provides all the performance information you need in one easy to read gauge. Individual elements can also be emphasized to further enhance user friendliness, functionality, and reliability.

SMG4



SPECIFICATIONS

- 3.5 Color Display
- Size: 105mm(W)x105mm(H)x16mm(D)
- Easy installation and setup
- NMEA2000 output
- Applicable model: DF9.9B - DF350A

FEATURES

- Can be operated with both digital and analog readout
- Incorporates day and night modes
- Displays the QR code for the Suzuki Diagnostic System

* Speed sensor or GPS module will be required in order to display the Speed, Mileage and Trip distance. In order to display Time, GPS module will be required.

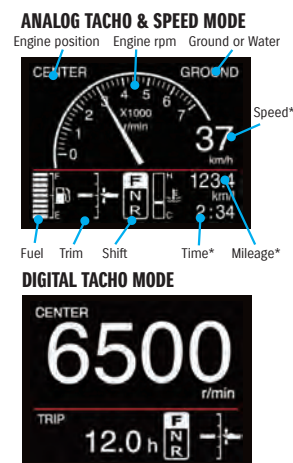

TROLL MODE

TROLL MODE FUNCTION

- Allows you to control your troll mode from the Suzuki Multi-Function Gauge

This function is available from year 2019 models. It can only be used by models which are adapted to troll mode.



SUZUKI PRECISION CONTROL For Drive-By-Wire System

DF350A DF325A DF300B DF300AP DF250AP DF200AP DF175AP DF150AP DF140BG DF115BG

Our sophisticated drive-by-wire system eliminates the friction and resistance.

This gives smooth, precise control with crisp, immediate shifting, particularly at low revs and when maneuvering. The system can be configured with single, twin, triple, or quad installations, and for dual stations.

Suzuki Precision Control also features built-in systems that help guard the engine and drive against damage, so you can further experience the better boating life.

Main Features of SUZUKI PRECISION CONTROL

- Suzuki Precision Control offers smooth and positive gear operation.
- Smooth power transitions when power is required.
- Combined with Suzuki's Lean Burn Control system, it delivers remarkable fuel economy over a wide operating range.



BINNACLE MOUNT R/C BOX for DUAL/TRIPLE/QUAD ENGINE



FLUSH MOUNT R/C BOX for SINGLE ENGINE

BINNACLE MOUNT R/C BOX for SINGLE ENGINE

WATERGRIP PROPELLER

WATERGRIP is a stainless-steel propeller series offering accurate response to your operation. With efficient conversion of engine power into propulsion, this propeller series meets our customers' demand for bigger, faster, more powerful outboards.

The WATERGRIP propeller series employs a new interchangeable and square shaped propeller bush that minimizes power loss in delivery.

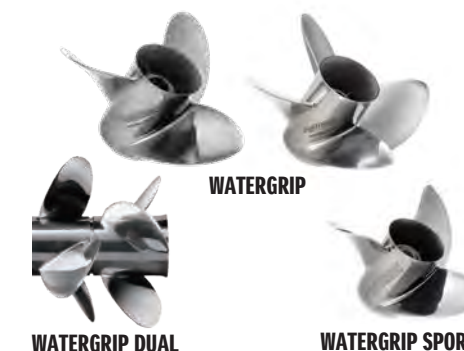
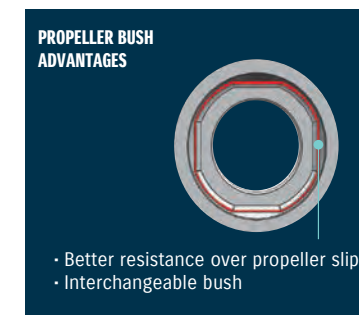

MULTI-FUNCTION TILLER HANDLE

DF115A DF100A DF100B DF90A DF80A DF70A DF60AV DF50AV DF60A DF50A DF40A



Main features

Tachometer with warning indicators

Three-position angle adjustable bracket

Troll mode switch*
• Activates SUZUKI Troll Mode System and controls RPM from idling engine speed up to 1200rpm at every 50rpm.

Power trim & tilt switch and throttle grip friction adjuster

*Not available for DF90AWQH

MAINTENANCE KITS

ALL MODELS

We are now offering complete maintenance kits on a range of Suzuki outboards. Each kit has the complete range of Suzuki Genuine Parts required for servicing Suzuki outboards according to the periodical maintenance schedule as detailed in the owner's manual.*1

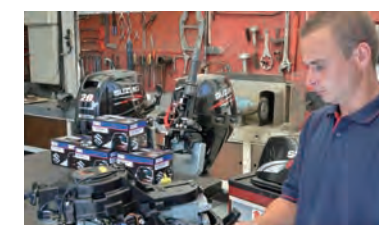

*1 Includes parts that require exchange at the dealer.

BATTERY CHARGING KIT

DF30A DF25A DF20A DF15A DF9.9B DF9.9A DF8A DF6A DF5A DF4A

- Optional equipment for charging battery

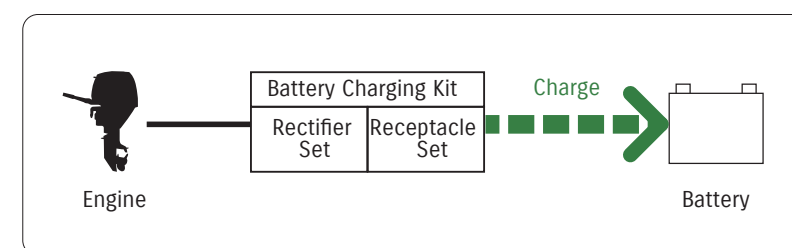

SUZUKI KEYLESS START SYSTEM*2

►DF70A and above (not including DF250/225/200 DF250W, DF150W, DF90AWQH)

A proximity keyless fob that transmits an access code to the engine's starting system.

How to use

1. Stand within a meter of the console with your key fob
2. Turn on the main switch
3. Press the start button and you are ready to go

Advantage

- Reduces the risk of a lost key
- Makes for an excellent theft deterrent as the outboard will not start without the proper access code
- The keyless fob floats on water in case it goes overboard

*2 Availability may differ in some regions. Please contact your local Suzuki dealer for more information.



Find out more by watching our videos

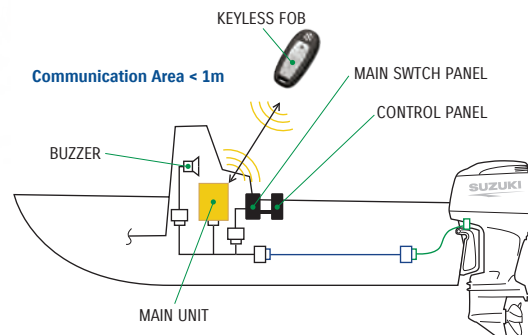

SUZUKI DIAGNOSTIC SYSTEM MOBILE

►DF9.9B AND UP* *Available with SMD or SMG

Simple and Easy

Read QR code*3 containing engine information and send it by e-mail. This is a service tool that anyone can use.

How to use

1. The outboard sends engine data and converts it into a QR code displayed on the Suzuki Multi-Function Gauge or Suzuki Multi-Function Display.
2. With the SUZUKI DIAGNOSTIC SYSTEM MOBILE application, you can scan the QR code on the Suzuki Multi-Function Gauge or Suzuki Multi-Function Display with your phone. The engine data will be stored on your smart phone.
3. You can then send the engine data via email to your Suzuki Dealer.



Apple and the Apple logo are trademarks of Apple Inc., registered in the U.S. and other countries. App Store is a service mark of Apple Inc., registered in the U.S. and other countries.



Google Play and the Google Play logo are trademarks of Google LLC.

Available for Free

To make it available for as many customers as possible, customers using the Suzuki Multi-Function Gauge and Suzuki Multi-Function Display can use it for free. In order to use it, a smartphone running Android or iOS is required.

* SUZUKI DIAGNOSTIC SYSTEM MOBILE is free of charge.

Advantages to customers

- This app can show you information like cruising hours at each rpm and is useful when reviewing your cruising journey.
- Enables you to easily provide necessary engine information to the service personnel when your outboard needs maintenance.

Advantages to dealers and service personnel

- Enables you to obtain engine information more easily. No longer necessary to remove the engine cover and connect a personal computer.
- If any malfunction should occur in a customer's outboard, you can check the accurate engine information sent by the customer before going to the site.

*3 DENSO WEB owns the right of the name and the logo of QR code.

COUNTER SELECT CONNECTOR

►DF300AP ►DF250AP ►200AP ►DF175AP ►DF150AP

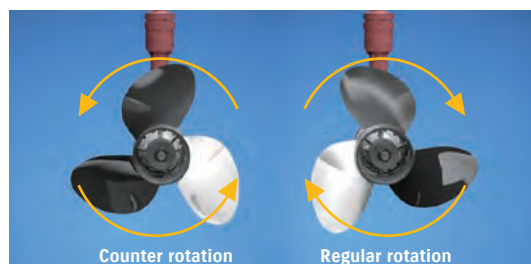

Converts the outboard to counter rotation specification. This industry first is made possible through a special, unified design of gears, shaft, and bearings in the lower unit.

Advantage

- Eliminates the need to purchase a dedicated counter rotation outboard.



* Make sure you consult with your Suzuki authorized dealer before changing Regular Rotation to Counter Rotation (or vice versa). Counter rotational propeller will also be needed along with the Counter Select Connector.

Suzuki Clean Ocean Project

As the world's ULTIMATE OUTBOARD MOTOR BRAND, Suzuki always remains focused on providing the ultimate marine experience, which requires a healthy and clean marine environment. Since 2011, for 9 years and counting, we have been voluntarily conducting the "Clean-up the World Campaign" every year to contribute to a better marine environment and more than 8,000 people have participated. In Japan, the campaign has been officially recognized by the Ministry of the Environment in the "Plastic Smart Campaign". To continue to make our utmost effort for environmental protection, it is now time for us to review how we have been contributing to the environment and society and newly determine our direction. As well as continuing our worldwide clean-up campaign, we will also commit to take responsible actions against plastic waste problems. This is how we came to make the new Slogan and Logo, "Suzuki Clean Ocean Project", to show the world our commitment.

Our commitment

1. Continue our actions to clean the marine environment all over the world
2. Reduce plastic used in the packaging of our products
3. Reduce marine micro-plastic waste



We believe the actions Team Suzuki takes around the world will be one positive step forward to a cleaner marine environment.

SUZUKI'S 9TH CLEAN-UP THE WORLD CAMPAIGN THE ULTIMATE OUTBOARD MOTOR

As the "ULTIMATE OUTBOARD MOTOR" brand, we are constantly focused on providing the ultimate marine experience to the marine world, and that must always require a healthy and clean marine environment. This is where the idea of the clean-up campaign originated, and came to become the "Clean Up the World Campaign" that started in 2011.



Country	Company	Participants
UK	SUZUKI GB PLC	6
Germany	SUZUKI DEUTSCHLAND GMBH	8
Poland	SUZUKI MOTOR POLAND SP.ZO.O.	12
Russia	1000 SIZE CO., LTD.	6
Russia	STINGRAY CO., LTD.	9
France	SUZUKI FRANCE S.A.S.	32
Italy	SUZUKI ITALIA SPA	50
Nigeria	BOULOS ENTERPRISES LTD.	100
South Africa	SUZUKI AUTO SOUTH AFRICA (PTY) LTD.	100
Maldives	MALDIVES TRANSPORT AND CONTRACTING COMPANY PLC	30
Mauritius	EMCAR LIMITED	51
Indonesia	PT. SUZUKI INDOMOBIL SALES	160
Australia	HAINES SUZUKI MARINE PTY. LTD.	24
China	SUZUKI MOTOR (CHINA) INVESTMENT CO., LTD.	30
Japan	SUZUKI MOTOR CORPORATION / SUZUKI MARINE CO.,LTD.	109
USA	SUZUKI MOTOR OF AMERICA, INC.	60
Mexico	SUZUKI MOTOR OF MEXICO S.A. DE C.V.	100
Guatemala	SUZUKI S.A.	100
Puerto Rico	SUZUKI DEL CARIBE, INC.	27
Colombia	SUZUKI MOTOR DE COLOMBIA S.A.	100
El Salvador	TRADER, S.A. DE C.V.	60
Brazil	GHANDI SECAF VEICULOS LTDA.	20
Tahiti	NIPPON AUTOMOTO (NAUTISPORT)	110
Vanuatu	INTRAPACIFIC TRADING CO., LTD.	100
New Caledonia	AUTOCAL SAS	20
Philippines	SUZUKI PHILIPPINES INC.	308
Thailand	THAI SUZUKI MOTOR CO., LTD	200
Vanuatu	UKI-CITY KUMAMOTO-PREF.	8
Brazil	IMIZU-CITY TOYAMA-PREF.	4
Brazil	AKASHI-CITY HYOGO-PREF.	5
Brazil	HATUKAICHI-CITY HIROSHIMA-PREF.	4
Japan	ISHIKARI-CITY, HOKKAIDO	4
Japan	IWAKI-CITY, FUKUSHIMA-PREF.	40
Japan	KISARAZU-CITY CHIBA-PREF.	15
Japan	MATSUYAMA-CITY, EHIME PREF.	7
Japan	CHITA-CITY AICHI-PREF.	4
Japan	TOYOKAWA-CITY AICHI-PREF.	7
Japan	KOSAI-CITY SHIZUOKA-PREF.	7

Our "Clean-Up the World Campaign" is now part of the Ministry of the Environment's "Plastic Smart Campaign" in Japan. For more information please visit: <http://plastics-smart.env.go.jp/en/>

Continuously evolving over the decades, Suzuki has a rich, proud history knowing no bounds.

D55

The first Suzuki Outboard, D55, was marketed.

SPECIFICATIONS

2-stroke
cylinder : 1
displacement : 98cm³
maximum output : 4.0kW (5.5PS)



1965

1977

DT200 Exanté

DT200 Exanté won the first "Most Innovative Products" award from the show's sponsor, the National Marine Manufacturers association (NMMA).

SPECIFICATIONS

2-stroke
cylinder : V6
displacement : 2,693cm³
maximum output : 147.1kW (200PS)



1987

1994

DF60

DF60 and DF70, the first Suzuki 4-stroke outboards with Electric Fuel Injection System, were marketed. DF60 and DF70 won the "NMMA Innovation Award"

SPECIFICATIONS

4-stroke
cylinder : 4
displacement : 1,298cm³
maximum output : 44.1kW (60PS)



1997

2003

DF300

DF300 is the industry's first 220.7kW(300PS) V6 4-stroke outboard, and the first outboard to utilize an electronic remote control. DF300 is the winner of the "NMMA 2006 Innovation Award".

SPECIFICATIONS

4-stroke
cylinder : V6
displacement : 4,028cm³
maximum output : 220.7kW (300PS)



2006

2014

DF350A

Suzuki introduces DF350A 257.4kW(350PS) V6 4-stroke outboard. New Flagship Model has exclusive features such as the innovative Suzuki Dual Prop System. DF350A is the winner of the "NMMA 2017 Innovation Award".

SPECIFICATIONS

4-stroke
cylinder : V6
displacement : 4,390cm³
maximum output : 257.4kW (350PS)



2017

2020

2020 will mark the 100th anniversary of Suzuki's long history.

With the rich history of 100 years, and the experience and knowledge of automobile, motorcycle, and outboard motor development, Suzuki has come to provide technology and service unprecedented in the marine business. Combined with the "Yamaika" spirit, Suzuki has grown to create innovation and satisfaction to customers around the world.

DT5

The DT5 was released as a compact 5PS outboard motor. Mounted 2-cylinder engine on, while 1-cylinder had been used for conventional 5PS outboard motor at that time, it delivered powerful propulsion.

SPECIFICATIONS

2-stroke
cylinder : 2
displacement : 113cm³
maximum output : 3.7kW (5PS)



DF9.9

Suzuki introduced DF9.9 and DF15, their first 4-stroke outboards.

SPECIFICATIONS

4-stroke
cylinder : 2
displacement : 302cm³
maximum output : 7.3kW (9.9PS)



DF250

DF250 is the industry's first 184kW(250PS) 4-stroke outboard. DF200/225/250, the first Suzuki 4-stroke V6 outboards were revealed. DF250 won the "NMMA Innovation Award" at the 2003 International Miami Boat Show.

SPECIFICATIONS

4-stroke
cylinder : V6
displacement : 3,614cm³
maximum output : 184.0kW (250PS)



DF200AP

DF200A/DF200AP are 4-stroke outboard motors based on in-line 4-cylinder engine of the DF175. In addition, DF200AP has adopted the Suzuki Selective Rotation, the world's first technology to integrate both regular and counter rotations of a propeller. The control system utilizes electronic throttle and shift systems.

SPECIFICATIONS

4-stroke
cylinder : In-line4
displacement : 2,867cm³
maximum output : 147.1kW(200PS)



DF90AWQH

DF90AWQH was developed to meet the demand of commercial fishing. It is the first Cargo series model which is Suzuki's first commercial series.

SPECIFICATIONS

4-stroke
cylinder : 4
displacement : 1,502cm³
maximum output : 66.2kW(90PS)



SPECIFICATIONS & FEATURES



SPECIFICATIONS

	350A	325A	300B	300AP	250AP	250	225	200	200AP	175AP	150AP	200A	175A	150A	140BG	115BG	140A	115A	100A	100B	90A	80A	70A	90ATH	70ATH	250W (Cargo)	150W (Cargo)	90AWQH (Cargo)
RECOMMENDED TRANSOM HEIGHT mm	X: 635 XX: 762			L: 508 X: 635 XX: 762	L: 508 X: 635 XX: 762	L: 508 X: 635 XX: 762	X: 635 XX: 762	L: 508 X: 635 XX: 762	L: 508 X: 635			Electric	Electric		L: 508 X: 635		L: 508 X: 635		L: 508 X: 635	L: 508 X: 635			L: 508 X: 635	X: 635 XX: 762	L: 508 X: 635	L: 508 X: 635		
STARTING SYSTEM	Electric			Electric		Electric			Electric		Electric	Electric		Electric		Electric				Electric		Electric		Electric				
WEIGHT kg*	X: 330 XX: 339			L: 284 X: 290 XX: 299	L: 264 X: 275 XX: 284	X: 275 XX: 284	L: 264 X: 275 XX: 284	L: 236 X: 241	L: 235 X: 240	L: 235 X: 240	L: 188 X: 192	L: 190 X: 194	L: 181 X: 185	L: 183 X: 187	L: 157 X: 161	L: 156 X: 160			L: 162 X: 166	X: 279 XX: 288	L: 232 X: 237	L: 158 X: 162						
CYLINDERS	V6 (55°)			V6 (55°)		V6 (55°)			In-line 4		In-line 4	In-line 4	In-line 4		In-line 4				In-line 4	V6 (55°)	In-line 4							
ENGINE TYPE	DOHC 24-Valve			DOHC 24-Valve		DOHC 24-Valve			DOHC 16-Valve		DOHC 16-Valve	DOHC 16-Valve	DOHC 16-Valve	DOHC 16-Valve		DOHC 16-Valve				DOHC 16-Valve	DOHC 24-Valve	DOHC 16-Valve						
FUEL DELIVERY SYSTEM	Electronic Fuel Injection			Electronic Fuel Injection		Electronic Fuel Injection			Electronic Fuel Injection		Electronic Fuel Injection	Electronic Fuel Injection	Electronic Fuel Injection	Electronic Fuel Injection		Electronic Fuel Injection				Electronic Fuel Injection	Electronic Fuel Injection							
PISTON DISPLACEMENT cm³	4,390			4,028		3,614			2,867		2,867	2,867	2,045		1,502				1,502	3,614	2,867	1,502						
BORE X STROKE mm	98 x 97			98 x 89		95 x 85			97 x 97		97 x 97	97 x 97	86 x 88		86 x 88				75 x 85	75 x 85	95 x 85	97 x 97	75 x 85					
MAXIMUM OUTPUT kw	257.4	239.0	220.7	220.7	183.9	183.9	165.5	147.1	128.7	110.3	147.1	128.7	110.3	103.0	84.6	103.0	84.6		73.6	66.2	58.8	51.5	66.2	51.5	183.9	110.3	66.2	
FULL THROTTLE OPERATING RANGE rpm	5,700-6,300		5,300-6,300		5,700-6,300	5,500-6,100	5,500-6,100	5,500-6,100		5,500-6,100	5,500-6,100		5,000-6,000	5,600-6,200	5,000-6,000	5,600-6,200	5,000-6,000		5,700-6,300		5,000-6,000		5,300-6,300	5,000-6,000	5,500-6,100	5,000-6,000	5,300-6,300	
STEERING	Remote (DBW)			Remote (DBW)		Remote (Mechanical)			Remote (DBW)		Remote (Mechanical)	Remote (Mechanical)	Remote (DBW)	Remote (Mechanical)		Remote (Mechanical)				Tiller	Remote (Mechanical)	Tiller						
OIL PAN CAPACITY L	8.0			8.0		8.0			8.0		8.0	8.0		5.5		5.5				4.3		4.3		8.0		4.3		
RECOMMENDED FUEL**	RON94/AKI89	RON91/AKI87	RON94/AKI89	RON94/AKI89		RON91/AKI87			RON91/AKI87		RON91/AKI87	RON91/AKI87	RON91/AKI87	RON91/AKI87		RON91/AKI87				RON91/AKI87		RON91/AKI87						
FUEL TANK CAPACITY L	-			-		-			-		-	-	-	-	-		Separate(optional)25				Separate(optional)25	-	Separate(optional)25					
ALTERNATOR	12V 54A			12V 54A		12V 54A			12V 44A		12V 44A	12V 44A	12V 40A		12V 40A				12V 27A		12V 27A		12V 54A	12V 44A	12V 27A			
TRIM METHOD	Power Trim and Tilt			Power Trim and Tilt		Power Trim and Tilt			Power Trim and Tilt		Power Trim and Tilt	Power Trim and Tilt	Power Trim and Tilt	Power Trim and Tilt		Power Trim and Tilt				Power Trim and Tilt	Power Trim and Tilt	Power Trim and Tilt	Gas Assisted Tilt					
GEAR RATIO	2.29:1		2.08:1		2.29:1			2.50:1		2.50:1	2.50:1	2.59:1		2.59:1		2.59:1	2.59:1		2.59:1	2.59:1		2.59:1		2.29:1	2.50:1	2.59:1		
GEAR SHIFT	F-N-R			F-N-R		F-N-R			F-N-R		F-N-R	F-N-R	F-N-R		F-N-R				F-N-R		F-N-R		F-N-R					
EXHAUST	Through Prop Hub Exhaust			Through Prop Hub Exhaust		Through Prop Hub Exhaust			Through Prop Hub Exhaust		Through Prop Hub Exhaust	Through Prop Hub Exhaust	Through Prop Hub Exhaust	Through Prop Hub Exhaust	Through Prop Hub Exhaust		Through Prop Hub Exhaust				Through Prop Hub Exhaust	Through Prop Hub Exhaust						
PROPELLER SELECTION (PITCH)	12"-31.5"			15"-27.5"(R/R) 17"-26"(C/R)		15"-27.5"(R/R) 17"-26"(C/R)			15"-27.5"(R/R) 17"-26"(C/R)		15"-27.5"(R/R) 17"-26"(C/R)	15"-27.5"(R/R) 17"-26"(C/R)	15"-25"(R/R) 17"-23"(C/R)	15"-25"(R/R) 17"-23"(C/R)	15"-25"(R/R) 17"-23"(C/R)		13"-25" (R/R)				13"-25" (R/R)		15"-27.5"(R/R) 17"-26"(C/R)		13"-25" (R/R)			

All propellers are the 3-blade type. please inquire at your local dealer for details of the propeller.

*1: Dry Weight: Including battery cable, not including propeller and engine oil. *2: RON: Research method (minimum octane rating) AKI: (R+M)/2 method(minimum pump octane rating), (Only North America)

FEATURES

●=Standard Equip. ○=Optional Equip.

	350A	325A	300B	300AP	250AP	250	225	200	200AP	175AP	150AP	200A	175A	150A	140BG	115BG	140A	115A	100A	100B	90A	80A	70A	90ATH	70ATH	250W (Cargo)	150W (Cargo)	90AWQH (Cargo)	
BODY COLOR	BLACK	●	●	●	●	●	●	●	●	●	●	●	●	●	●	●	●	●	●	●	●	●	●	●	●	●	●	●	●
	NEW WHITE	●	●	●	●	●	●	●	●	●	●	●	●	●	●	●	●	●	●	●	●	●	●	●	●	●	●	●	●
SUZUKI SELECTIVE ROTATION	●	●	●	●	●	●	●	●	●	●	●	●	●	●	●	●	●	●	●	●	●	●	●	●	●	●	●	●	●
SUZUKI PRECISION CONTROL SYSTEM	●	●	●	●	●	●	●	●	●	●	●	●	●	●	●	●	●	●	●	●	●	●	●	●	●	●	●	●	●
2-STAGE GEAR REDUCTION SYSTEM	●	●	●	●	●	●	●	●	●	●	●	●	●	●	●	●	●	●	●	●	●	●	●	●	●	●	●	●	●
VARIABLE VALVE TIMING SYSTEM	●	●	●	●	●	●	●	●	●	●	●	●	●	●	●	●	●	●	●	●	●	●	●	●	●	●	●	●	●
MULTI-STAGE INDUCTION SYSTEM	●	●	●	●	●	●	●	●	●	●	●	●	●	●	●	●	●	●	●	●	●	●	●	●	●	●	●	●	●
OFFSET DRIVESHAFT	●	●	●	●	●	●	●	●	●	●	●	●	●	●	●	●	●	●	●	●	●	●	●	●	●	●	●	●	●
DIRECT IGNITION	●	●	●	●	●	●	●	●	●	●	●	●	●	●	●	●	●	●	●	●	●	●	●	●	●	●	●	●	●
SELF-ADJUSTING TIMING CHAIN	●	●	●	●	●	●	●	●	●	●	●	●	●	●	●	●	●	●	●	●	●	●	●	●	●	●	●	●	●
SUZUKI LEAN BURN CONTROL SYSTEM	●	●	●	●	●	●	●	●	●	●	●	●	●	●	●	●	●	●	●	●	●	●	●	●	●	●	●	●	●
O2 SENSOR FEEDBACK CONTROL SYSTEM	●	●	●	●	●	●	●	●	●	●	●	●	●	●	●	●	●	●	●	●	●	●	●	●	●	●	●	●	●
SUZUKI EASY START SYSTEM	●	●	●	●	●	●	●	●	●	●	●	●	●	●	●	●	●	●	●	●	●	●	●	●	●	●	●	●	●
OVER-REV. LIMITER	●	●	●	●	●	●	●	●	●	●	●	●	●	●	●	●	●	●	●	●	●	●	●	●	●	●	●	●	●
LOW OIL PRESSURE CAUTION	●	●	●	●	●	●	●	●	●	●	●	●	●	●	●	●	●	●	●	●	●	●	●	●	●	●	●	●	●
FRESH WATER FLUSHING SYSTEM	●	●	●	●	●	●	●	●	●	●	●	●	●	●	●	●	●	●	●	●	●	●	●	●	●	●	●	●	●
SUZUKI TROLL MODE SYSTEM	○	○	○	○	○	○	○	○	○	○	○	○	○	○	○	○	○	○	○	○	○	○	○	○	○	○	○	○	○
TILT LIMIT SYSTEM	●	●	●	●	●	●	●	●	●	●	●	●	●	●	●	●	●	●	●	●	●	●	●	●	●	●	●	●	●
DUAL WATER INLET	●	●	●	●	●	●	●	●	●	●	●	●	●	●	●	●	○	○	○	○	○	○	○	○	○	○	○	○	○
COUNTER ROTATION MODEL	●	●	●	●	●	●	●	●	●	●	●	●	●	●	●	●	●	●	●	●	●	●	●	●	●	●	●	●	●
WATER DETECTING SYSTEM	●	●	●	●	●	●	●	●	●	●	●	●	●	●	●	●	●	●	●	●	●	●	●	●	●	●	●	●	●
HIGH ENERGY ROTATION	●	●	●	●	●	●	●	●	●	●	●	●	●	●	●	●	●	●	●	●	●	●	●	●	●	●	●	●	●
SHALLOW WATER DRIVE	●	●	●	●	●	●	●	●	●	●	●	●	●	●	●	●	●	●	●	●	●	●	●	●	●	●	●	●	●
THREE-WAY STORAGE	●	●	●	●	●	●	●	●	●	●	●	●	●	●	●	●	●	●	●	●	●	●	●	●	●	●	●	●	●
SUZUKI ANTI-CORROSION SYSTEM	●	●	●	●	●	●	●	●	●	●	●	●	●	●	●	●	●	●	●	●	●	●	●	●	●	●	●	●	●
OVERHEAD TANK	●	●	●	●	●	●	●	●	●	●	●	●	●	●	●	●	●	●	●	●	●	●	●	●	●	●	●	●	●
SUZUKI DIAGNOSTIC SYSTEM MOBILE	○	○	○	○	○	○	○	○	○	○	○	○	○	○	○	○	○	○	○	○	○	○	○	○	○	○	○	○	○

SPECIFICATIONS & FEATURES

SPECIFICATIONS

	60A/50A/40A	60ATH	50ATH/40ATH	60AQH/40AQH	60AV/50AV	60AVTH/50AVTH	30AT/25AT	30ATH/25ATH	30AR	30AQH/25AQH	30A/25A	20AT/15AT/9.9BT	20ATH/15ATH/9.9BTH	20AR/15AR/9.9BR	20A/15A/9.9B	8AR	9.9A/8A	6A/5A/4A	2.5		
RECOMMENDED TRANSOM HEIGHT mm	S: 381 L: 508 X: 635*3	L: 508 X: 635*3			L: 508 X: 635*3		S: 381 L: 508	S: 381** L: 508	S: 381 L: 508	L: 508	L: 508 S: 381	S: 381** L: 508 X: 635**	S: 381** L: 508 X: 635**	S: 381 L: 508		L: 508	L: 508 S: 381	S: 381 L: 508	S: 381 L: 508		
STARTING SYSTEM	Electric						Electric/Manual			Manual	Electric/Manual	Manual	Electric/Manual			Manual	Electric/Manual	Manual	Manual	Manual	
WEIGHT kg*1	S: 102 L: 104 X: 107*3	L: 110 X: 113*3		L: 108 X: 111*3	L: 115 X: 118*3	L: 121 X: 124*3	S: 71 L: 72	S: 73** L: 74	S: 63 L: 64	L: 73	L: 70 S: 65	S: 62 L: 63	S: 52.5** L: 54.5 X: 57**	S: 53.5** L: 55.5 X: 58**	S: 47 L: 48	S: 48 L: 49	S: 44 L: 45	L: 43.5	L: 46 S: 39 L: 41.5	S: 24 L: 25	S: 13.5 L: 14
CYLINDERS	In-line 3						In-line 3			In-line 3			In-line 2			In-line 2		1	1		
ENGINE TYPE	DOHC 12-Valve						OHC			OHC			OHC			OHC		OHV	OHV		
FUEL DELIVERY SYSTEM	Electronic Fuel Injection						Battery-less Electronic Fuel Injection			Battery-less Electronic Fuel Injection			Battery-less Electronic Fuel Injection			Carburetor		Carburetor	Carburetor		
PISTON DISPLACEMENT cm ³	941						490			490			327			208		138	68		
BORE X STROKE mm	72.5 x 76	72.5 x 76		72.5 x 76		60.4 x 57						60.4 x 57			60.4 x 57			51 x 51		60.4 x 48	48 x 38
MAXIMUM OUTPUT kw	DF60A: 44.1 DF50A: 36.8 DF40A: 29.4	44.1	DF50A: 36.8 DF40A: 29.4	DF60A: 44.1 DF50A: 36.8 DF40A: 29.4		DF30A: 22.1 DF25A: 18.4			DF30A: 22.1 DF25A: 18.4			DF20A: 14.7 DF15A: 11.0 DF9.9B: 7.3			DF9.9A: 7.3 DF8A: 5.9		DF6: 4.4 DF5: 3.7 DF4: 2.9	1.8			
FULL THROTTLE OPERATING RANGE rpm	5,300-6,300 DF50A: 5,300-6,300 DF40A: 5,000-6,000	5,300-6,300	DF50A: 5,300-6,300 DF40A: 5,000-6,000	DF60A: 5,300-6,300 DF50A: 5,300-6,300 DF40A: 5,000-6,000		DF30A: 5,300-6,300 DF25A: 5,000-6,000			DF30A: 5,300-6,300 DF25A: 5,000-6,000			DF20A: 5,300-6,300 DF15A: 5,000-6,000 DF9.9B: 4,700-5,700			DF9.9A: 5,200-6,200 DF8A: 4,700-5,700		DF6: 4,750-5,750 DF5: 4,500-5,500 DF4: 4,000-5,000	5,250-5,750			
STEERING	Remote (Mechanical)	Tiller		Remote (Mechanical)	Tiller	Remote (Mechanical)	Tiller	Remote (Mechanical)	Tiller			Remote (Mechanical)	Tiller	Remote (Mechanical)	Tiller	Remote (Mechanical)	Remote (Mechanical), Tiller	Tiller, 180°rotation	Tiller, 360°rotation		
OIL PAN CAPACITY L	2.7						1.5			1.5			1.0			0.8		0.7	0.38		
RECOMMENDED FUEL**2	RON91/AKI87						RON91/AKI87			RON91/AKI87			RON91/AKI87			RON91/AKI87		RON91/AKI87	RON91/AKI87		
FUEL TANK CAPACITY L	Separate(optional)25						Separate(optional)25			Separate(optional)25			Separate(optional)12			Separate(optional)12		Integral 1	Integral 0.9		
ALTERNATOR	12V 19A						12V 14A			12V 14A			12V 12A			12V 6A	12V 10A	12V 6A	12V 5A (op.)	-	
TRIM METHOD	Power Trim and Tilt		Manual Trim & Gas Assisted Tilt	Power Trim and Tilt		Power Trim and Tilt	Manual Trim & Tilt	Gas Assisted Trim & Tilt	Manual Trim and Tilt		Power Tilt		Manual Trim and Tilt			Manual Trim and Tilt		Manual Trim and Tilt	Manual Trim and Tilt	Manual Trim and Tilt	
GEAR RATIO	2.27:1			2.42:1			2.09:1			2.09:1			2.08:1			2.08:1		1.92:1		2.15:1	
GEAR SHIFT	F-N-R						F-N-R			F-N-R			F-N-R			F-N-R		F-N			
EXHAUST	Through Prop Hub Exhaust						Through Prop Hub Exhaust			Through Prop Hub Exhaust			Through Prop Hub Exhaust			Through Prop Hub Exhaust		Above Prop Exhaust	Above Prop Exhaust		
PROPELLER SELECTION (PITCH)	9"-17"						9"-15"			7"-12"			7"-11"		6"-7"		5.3/8"				

All propellers are the 3-blade type. please inquire at your local dealer for details of the propeller.

*1: Dry Weight: Including battery cable, not including propeller and engine oil. *2: RON: Research method (minimum octane rating). AKI: (R+M)/2 method (minimum pump octane rating), (Only North America)

*3: DF60A only. *4: DF25ATH only. *5: DF30AQH only. *6: DF25A only. *7: DF20AT/DF9.9BT only. *8: DF9.9BT only. *9: DF9.9BTH only. *10: DF8AE only.

FEATURES

●=Standard Equip. ○=Optional Equip.

	60A/50A/40A	60ATH	50ATH/40ATH	60AQH/40AQH	60AV/50AV	60AVTH/50AVTH	30AT/25AT	30ATH/25ATH	30AR	30AQH/25AQH	30A/25A	20AT/15AT/9.9BT	20ATH/15ATH/9.9BTH	20AR/15AR/9.9BR	20A/15A/9.9B	8AR	9.9A/8A	6A/5A/4A	2.5
BODY COLOR	BLACK	●	●	●	●	●	●	●	●	●	●	●*2	●*3	●	●	●	●	●*4	●
	WHITE	●					●	●				●	●		●			●	
SUZUKI SELECTIVE ROTATION																			
SUZUKI PRECISION CONTROL SYSTEM																			
2-STAGE GEAR REDUCTION SYSTEM																			
VARIABLE VALVE TIMING SYSTEM																			
MULTI-STAGE INDUCTION SYSTEM																			
OFFSET DRIVESHAFT																			
DIRECT IGNITION	●	●	●	●	●	●													
SELF-ADJUSTING TIMING CHAIN	●	●	●	●	●	●													
SUZUKI LEAN BURN CONTROL SYSTEM	●	●	●	●	●	●	●	●	●	●	●	●	●	●	●	●	●	●	●
O ₂ SENSOR FEEDBACK CONTROL SYSTEM																			
SUZUKI EASY START SYSTEM	●	●	●	●	●	●													
OVER-REV. LIMITER	●	●	●	●	●	●	●	●	●	●	●	●	●	●	●	●	●	●	●
LOW OIL PRESSURE CAUTION	●	●	●	●	●	●	●	●	●	●	●	●	●	●	●	●	●	●	●
FRESH WATER FLUSHING SYSTEM	●	●	●	●	●	●	●	●	●	●	●	●	●	●	●	●	●	●	●
SUZUKI TROLL MODE SYSTEM	○	●	●	●	○	●													
TILT LIMIT SYSTEM	●*1	●	●	●	●	●													
DUAL WATER INLET	●	●	●	●															
COUNTER ROTATION MODEL																			
WATER DETECTING SYSTEM																			
HIGH ENERGY ROTATION					●	●													
SHALLOW WATER DRIVE									●		●				●	●	●	●	●
THREE-WAY STORAGE																			
SUZUKI ANTI-CORROSION SYSTEM	●	●	●	●	●	●	●	●	●	●	●	●	●	●	●	●	●	●	●
OVERHEAD TANK																			
SUZUKI DIAGNOSTIC SYSTEM MOBILE	○	○	○	○	○	○	○	○	○	○	○	○	○	○	○	○	○	○	○

*1: DF60A only. *2: DF20AT/9.9BT only. *3: DF20ATH/9.9BTH only. *4: DF6A only.